

# JinkoSolar Photovoltaic Module



**User Manual (UL1703)**

*Solar*  
**Jinko**  
*Building Your Trust in Solar*

## Contents

1	General Information	1
1.1	Overview	1
1.2	Warnings	1
<hr/>		
2	Installation	4
2.1	Installation Safety	4
2.2	Installation Condition	5
2.2.1	Climate Condition	5
2.2.2	Site Selection	5
2.2.3	Tilt Angle Selection	6
2.3	Mechanical Installation Introduction	7
2.3.1	Mounting with Bolts	8
2.3.2	Mounting with Clamps	9
2.3.2.1	Clamp Mounting on Long Sides of the Frames	11
2.3.2.2	Clamp Mounting on Short Sides of the Frames	11
2.3.2.3	Clamp Mounting on Long & Short Sides	12
<hr/>		
3	Wiring and Connections	12
<hr/>		
4	Maintenance and Care	14
<hr/>		
5	Electrical Specification	15
<hr/>		
6	Disclaimer of Liability	15
<hr/>		
	Appendix 1 : Applicable Products	16
	Appendix 2 : Electrical Specifications	18
<hr/>		
	Contact us	33
<hr/>		

# 1. General Information

## 1.1 Overview

Thanks for choosing Jinko Solar PV modules. In order to ensure the PV modules are installed correctly, please read the following installation instructions carefully before modules are installed and used. Please remember that these products generate electricity and certain safety measures need to be taken to avoid danger. Make sure the module array is designed in such a way not to exceed the maximum system voltage of any system component such as connectors or inverters.

This module has a Class C Fire Rating (Canada) or Module Fire performance type 1 (United States of America) and must be installed over a roof which has appropriate fire resistance. Before mounting the module, please consult your local building department to determine approved roofing materials. The modules are qualified for application class A, and modules qualified for safety through UL 1703 within this application class are considered to meet the requirements of Safety Class II.

The Fire rating is Class C in Canada, but the Module Fire performance is type 1 in America with the specified construction in below table, when used with a listed mounting system that has been rated as a Class A System when installed with type 1 modules, is suitable to maintain the System Class A Fire Rating in America.

Module model	Specific construction	Marking
<b>Groups 1 ~ 16</b>	Superstrate: 3.2 ~ 4.0 mm thick; EVA: 0.25 ~ 0.8 mm thick; Substrate: 0.3 mm ~ 0.46 mm thick; Frame: Types "40mm by 20mm" or "40mm by 35mm" or "700-0218" or 35mm by 35mm	Module Fire Performance: Type 1

Notes: Groups 1 ~ 16 refer to appendix 1 for details.

## 1.2 Warnings

- PV modules generate DC electrical energy when exposed to sunlight or other light sources. Active parts of modules such as terminals can result in burns, sparks and lethal shock.
- Artificially concentrated sunlight shall not be directed on the module or panel.
- Front protective glass is utilized on the module. Broken solar module glass is an electrical safety



hazard (may cause electric shock or fire). These modules cannot be repaired and should be replaced immediately.

- To reduce the risk of electrical shocks or burns, modules may be covered with an opaque material during installation to avoid injury.
- The fire rating of this module is valid only when mounted in the manner specified in the mechanical mounting instructions.
- The module is considered to be in compliance with UL1703 only when the module is mounted in the manner specified by the mounting instructions below.
- All installations must be performed in compliance with the National Electrical Code (NEC) and modules installed in Canada need to follow Canadian Electric Code (CEC).
- A module with exposed conductive parts is considered to be in compliance with UL1703 only when it is electrically grounded in accordance with the instructions presented below and the requirements of the National Electrical Code.
- Any module without a frame (laminated) shall not be considered to comply with the requirements of UL1703 unless the module is mounted with hardware that has been tested and evaluated with the module under this standard or by a field inspection certifying that the installed module complies with the requirements of UL1703.
- The installation work of the PV array can only be done under the protection of sun-sheltering covers or sunshades and only qualified person can install or perform maintenance work on this module.
- Follow the battery manufacturer's recommendations, if batteries are used with modules.
- Do not use this module to replace or partly replace roofs and walls of living buildings.
- Do not install modules where flammable gas may be present.
- Do not touch live terminals with bare hands. Use insulated tools for electrical connections.



- Do not remove any part installed by Jinko Solar or disassemble the module.
- All instructions should be read and understood before attempting to install, wire, operate and maintain the module.
- Don't lift up PV modules using the attached cables or the junction box.
- All PV systems must be grounded to earth. If there is no special regulation, please follow the National Electrical Code or other national code.
- Common hardware items such as nuts, bolts, star washers, lock washers and the like have not been evaluated for electrical conductivity or for use as grounding devices and should be used only for maintaining mechanical connections and holding electrical grounding devices in the proper position for electrical conductivity. Such devices, where

supplied with the module and evaluated through the requirements in UL 1703, may be used for grounding connections in accordance with the instructions provided with the module.

- Under normal conditions, a photovoltaic module is likely to experience conditions that produce more current and/or voltage than reported at standard test conditions. The requirements of the National Electrical Code (NEC) in Article 690 shall be followed to address these increased outputs. In installations, not under the requirements of the NEC, the value of  $I_{sc}$  and  $V_{oc}$  marked on the module should be multiplied by a factor of 1.25 when determining component voltage ratings, conductor ampacities, overcurrent device ratings, and size of controls connected to the PV output.
- Once the PV module has been shipped to the installation site, all of the parts should be unpacked properly with care.
- Do not stand or step on the PV module like below pictures show. This is prohibited and there is a risk of damage to the module and cause injury for you.



- Only PV modules with the same cell size should be connected in series.
- During transporting modules, please attempt to minimize shock or vibration to the module, as this may damage the module or lead to cell micro cracks.
- During all transportation situations, never drop the module from a vehicle, house or hands. This will damage the module.
- Do not clean the glass with chemicals. Only use tap water. Make sure the module surface temperature is cool to the touch. Cleaning modules with cool water when module surface temp is high may result in glass breakage.
- Do not disconnect any of the modules when under load.
- The recommended standoff height is 6 inches (15cm). If other mounting means are employed this may affect the UL Listing.
- When looking at PV modules with anti-reflection (AR) coating technology, it will be normal to see some cells with a slight color difference at different angles. Modules with LRF (light reflective film) and without LRF should not be built in the same array.
- Do not use modules in an environment with aliphatic, aromatic, phenols, ketones, halogenated substance or mineral oil, which may corrode the junction box by chemical attack.

## 2. Installation

### 2.1 Installation Safety

- Always wear protective head gear, insulated gloves and safety shoes (with rubber soles).
- Keep the PV module packed in the carton until installation.
- Do not touch the PV module unnecessarily during installation. The glass surface and the frame may be hot. There is a risk of burns and electric shock.
- Do not work in rain, snow or windy conditions.
- Due to the risk of electrical shock, do not perform any work if the terminals of the PV module are wet.
- Use insulated tools and do not use wet tools.
- When installing PV modules, do not drop any objects (e.g., PV modules or tools).
- Make sure flammable gases are not generated or present near the installation site.
- The modules are equipped with PV wiring connectors that comply with UL 6703, Standard for Connectors for use in Photovoltaic Systems. Connectors from other manufactures should not be mated with each other connectors.

Connector model name	Allowable mating connector model name
TL-Cable01F	TL-Cable01M
PV-JK00MO	PV-JK00MO
UTXCFA4A*	UTXCMA4A*
Helios H4 Assembled	Helios H4 Assembled
PV-JK03M-1	PV-JK03M-1
PV-KST4/6II-UR	PV-KBT4/6II-UR
PV-JK03M-2	PV-JK03M-2
PV-JK03M-F/xy	PV-JK03M-M/xy
PV-KBT4-EVO2/6II-UR	PV-KST4-EVO2/6II-UR
PV-JK03M-F/2B	PV-JK03M-M/2B

**Table 1: Allowable mating connector model name**

- Insert module connectors fully and correctly. An audible "click" sound should be heard. This sounds confirms the connectors are fully seated. Check all connections.
- The module leads should be securely fastened to the module frame. Wire Management should be done in a way to avoid the connector from scratching or impacting the back sheet of the module.
- Do not touch the junction box and the end of the interconnect cables (connectors) with bare hands during installation or under sunlight, regardless if the PV module is connected to or disconnected from the system.
- Do not expose the PV module to excessive loads on the surface of the PV module or twist the frame.

- Do not hit or put excessive load on the glass or back sheet, this may break the cells or cause micro cracks.
- During installation or operation, don't use sharp tools to wipe the back sheet and glass. Scratches can appear on the module.
- Do not drill holes in the frame, it may cause corrosion of the frame and void the warranty.
- When installing modules on roof mounted structures, please try to follow the "from top to bottom" and/or "from left to right" principle, and don't step on the module. This will damage the module and would be dangerous for personal safety. For roof mounted applications, the assembly is to be mounted over a fire resistant roof covering rated for the application.
- All PV systems must be grounded to earth (Refer to 3. "Wiring and connection" for specific grounded).

## **2.2 Installation Condition**

### **2.2.1 Climate Condition**

Please install the modules in the following conditions:

- a) Operating temperature: within  $-40^{\circ}\text{C}$  ( $-40^{\circ}\text{F}$ ) to  $85^{\circ}\text{C}$  ( $185^{\circ}\text{F}$ ).
- b) Humidity:  $< 85\text{RH}\%$ .

\* Note:

The mechanical load bearing (including wind and snow loads) of the module is based on the approved mounting methods. The professional system installer must be responsible for mechanical load calculation according to the system design.

### **2.2.2 Site Selection**

In most applications, Jinko Solar PV modules should be installed in a location where they will receive maximum sunlight throughout the year. In the Northern Hemisphere, the module should typically face south, and in the Southern Hemisphere, the modules should typically face north. Modules facing 30 degrees away from true South (or North) will lose approximately 10 to 15 percent of their power output. If the module faces 60 degrees away from true South (or North), the power loss will be 20 to 30 percent.

When choosing a site, avoid trees, buildings or obstructions, which could cast shadows on the solar photovoltaic modules especially during the winter months when the arc of the sun is lowest over the horizon. Shading causes loss of output, even though the factory fitted bypass diodes of the PV module will minimize any such loss.

Do not install the PV module near open flame or flammable materials.

When solar modules are used to charge batteries, the battery must be installed in a manner, which will protect the performance of the system and the safety of its users. Follow the battery manufacturer's guidelines concerning installation, operation and maintenance recommendations. In general, the battery (or battery bank) should be away from the main flow of people and animal traffic. Select a battery site that is protected from sunlight, rain,

snow, debris, and is well ventilated. Most batteries generate hydrogen gas when charging, which can be explosive. Do not light matches or create sparks near the battery bank. When a battery is installed outdoors, it should be placed in an insulated and ventilated battery case specifically designed for the purpose.

Do not install the PV module in a location where it would be immersed in water or continually exposed to water from a sprinkler or fountain etc.

### 2.2.3 Tilt Angle Selection

The tilt angle of the PV module is measured between the surface of the PV module and a horizontal ground surface (Figure 1). The PV module generates maximum output power when it faces the sun directly.

For standalone systems with batteries where the PV modules are attached to a permanent structure, the tilt angle of the PV modules should be selected to optimize the performance based on seasonal load and sunlight. In general, if the PV output is adequate when irradiance is low (e.g., winter), then the angle chosen should be adequate during the rest of the year. For grid-connected installations where the PV modules are attached to a permanent structure, PV modules should be tilted so that the energy production from the PV modules will be maximized on an annual basis.

Only for UL listed products .The System Fire Class Rating of the module or panel in a mounting system in combination with a roof covering should complete the requirements to achieve the specified System Fire Class Rating for a non-BIPV module or panel.

Any module or panel mounting system have limitations on inclination required to maintain a specific System Fire Class Rating.

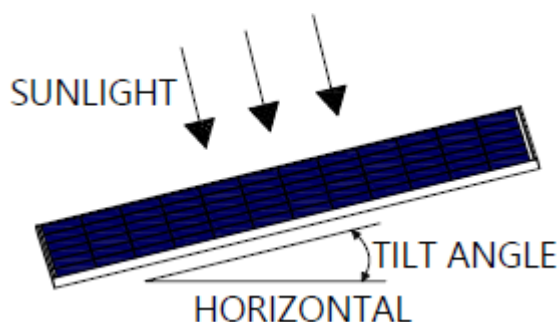

**Figure1: PV module tilt angle**

For bifacial modules, the suggested installation tilt angle and height is 30 degree and 1.2m, respectively. For different ground cover conditions, like snow, grass, desert, water surface, cement land and so on, the expectation generation energy gain varied from 4% to 24%, as shown in figure 2.

- i) The reflectivity of snow is 80-85%, generation energy will be increased by 17-24%.
- ii) The reflectivity of sand is 22-25%, generation energy will be increased by 7-14%.
- iii) The reflectivity of cement is 30-33 %, generation energy will be increased by 6-13%.
- iv) The reflectivity of grass is 10-20 %, generation energy will be increased by 6-8 %.
- v) The reflectivity of water is 2-5 %, generation energy will be increased by 4-7 %.



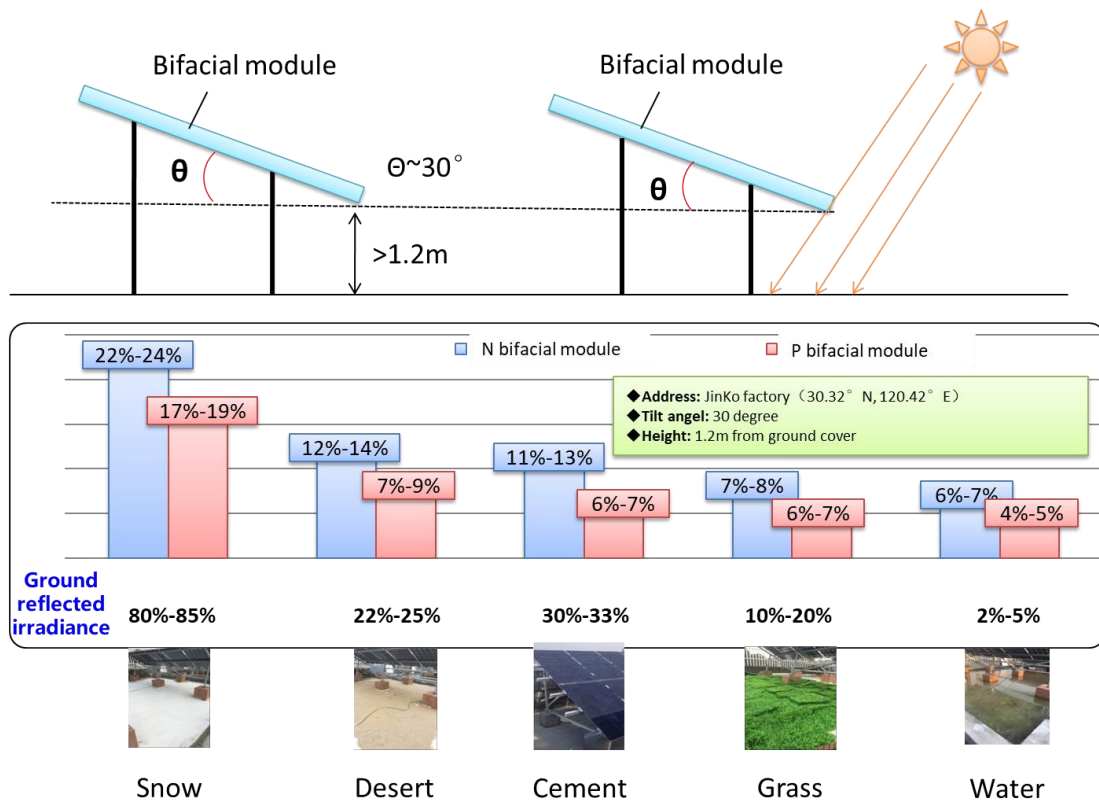

Figure2: PV module installed on different ground covers

### 2.3 Mechanical Installation Introduction

Solar PV modules usually can be mounted by using the following methods: bolts and clamps.

**\* Note:**

- (1) All installation methods herein are only for reference, and Jinko Solar will not provide related mounting components. The system installer or trained professional personnel must be responsible for the PV system’s design, installation, and mechanical load calculation and security of the system.
- (2) Before installation, the following items should be addressed:
  - 1) Visually check the module for any damage. Clean the module if any dirt or residue remains from shipping.
  - 2) Check if module serial number stickers match.
  - 3) The minimum distance between modules should be more than 10mm for all installation methods.
- (3) The mounting with bolts and/or clamps on the long side of the frames could meet a maximum positive testing (downward) pressure of 5400Pa and negative testing (upward) pressure of 2400Pa. The mounting with clamps on the short side of the frames could meet a positive testing (downward) pressure and negative testing (upward) pressure of 1600Pa. The mounting of clamps on the long & short sides of frames could meet a positive testing (downward) pressure and negative testing (upward) pressure of 2400Pa. with a 1.5 times safety factor.

When mounting modules in snow-prone or high-wind environments, special care should be taken to mount the modules in a manner that provides sufficient design strength while meeting local code requirements.

- (4) Where common grounding hardware (nuts, bolts, star washers, split-ring lock washers, flat washers and the like) is used to attach a listed grounding/bonding device, the attachment must be made in conformance with the grounding device manufacturer's instructions.
- (5) Common hardware items such as nuts, bolts, star washers, lock washers and the like have not been evaluated for electrical conductivity or for use as grounding devices and should be used only for maintaining mechanical connections and holding electrical grounding devices in the proper position for electrical conductivity. Such devices, where supplied with the module and evaluated through the requirements in UL1703, may be used for grounding connections in accordance with the instructions provided with the module.
- (6) The use of third party grounding device is not allowed unless the grounding device is UL2703 certified with Jinko modules. The installation of that grounding hardware must follow the grounding manufacture's installation manual.
- (7) The clearance between the module and the roof deck should be a minimum of 6 inches (15mm).

### 2.3.1 Mounting with Bolts

The frame of each module has 8 or 12 mounting holes used to secure the module to the support structure. The module frame must be attached to a mounting rail using M8 corrosion-proof bolts together with spring washers and flat washers in eight symmetrical locations on the PV module. The applied torque value should be big enough to fix the modules steadily. The torque value for a M8 bolt is 16~20 N\*m. For special racking systems or special installation requirements, please reconfirm with the supplier for the appropriate torque value. Please find detailed mounting information in figure 3. The installation instructions shall specify that the modules have been evaluated by UL for bolt mounting using the 8 provided mounting holes in the frame with a torque of 16~20 N\*m. The following M8 stainless steel mounting hardware should be included in the installation instructions: For eight 14x9 holes and four 10x7 holes (Red label for mounting hole), mounting hardware is shown below in Table 2:

Module	Mounting hardware configuration				Max. Pressure	
	Hardware	Material	Size (holes)			Number provided
			14x9	10x7		
Group 1 ~ 16	Bolt	Stainless steel	M8	M6	8/12	5400Pa (positive) & 2400Pa (negative) mechanical load
	Spring washer	Stainless steel	M8	M6	8/12	
	Nut	Stainless steel	M8	M6	8/12	

**Table 2: The mounting part for eight mounting holes**

\*Alternate Mounting Method – bolt mounting method using the 12 provided mounting holes in the frame with a torque of 16~20 N\*m. The following stainless steel mounting hardware should be included in the installation instructions.

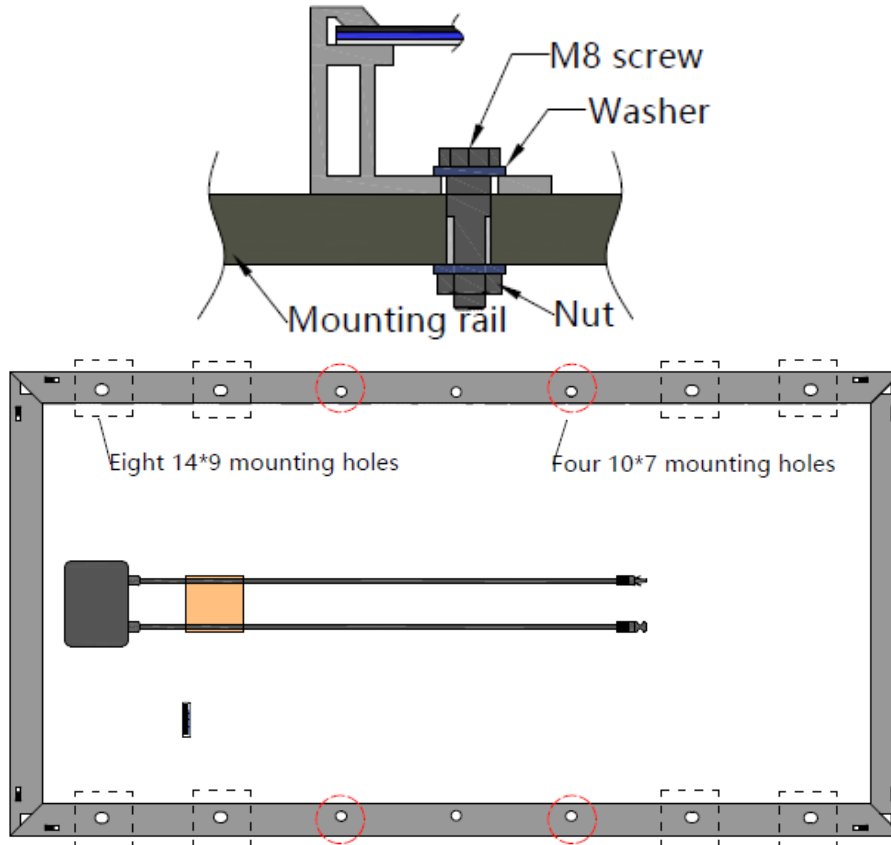

**Figure 3: PV module installed with Bolt fitting method**

### 2.3.2 Mounting with Clamps

The module clamps should not come into contact with the front glass and must not deform the frame. Be sure to avoid shading effects from the module clamps. The module frame is not to be modified under any circumstances. When choosing this type of mounting method, please be sure to use at least four clamps on each module, two clamps should be attached on each long side of the module. The applied torque value should be big enough to mount the modules steadily (Please consult with the clamp or racking supplier for the specific torque value). Please find detailed mounting information in the below illustration. The mounting zone is greater than J and less than K. Figure 4 shows how a clamp should be mounted to the module frame.

When installing modules using clamps on the long side of the frame, the applicable product types and installation locations are shown in figure 5 and table 4.

When installing modules using clamps on the short side of the frame, the applicable product types and installation locations are shown in figure 6 and table 5.

When installing modules using clamps on the long side & short side of the frame, the applicable product types and installation locations are shown in figure 7 and table 6.

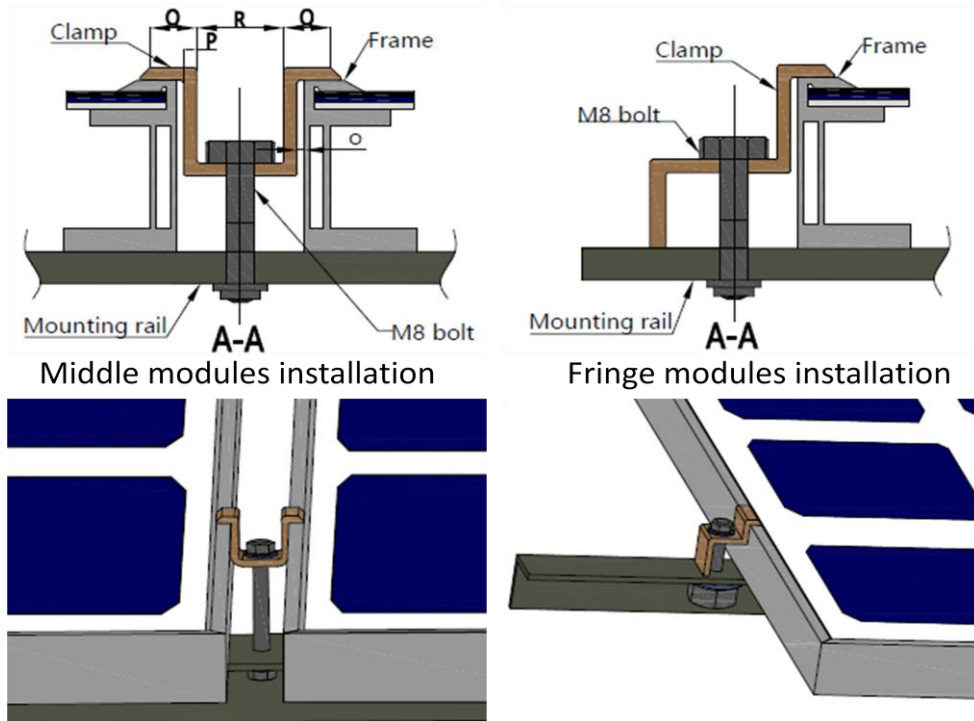

Figure 4: PV module installed at the side with Clamp fitting method

Clamp type	Dimension (mm)				Composition material
End Clamp (40mm thickness)	39x50x42				Aluminum-alloy
	39x60x42 (For 1.5mm thickness frame)				
End Clamp (35mm thickness)	41.5x50x40				
Middle Clamp	42x50x28				
	42x60x28 (For 1.5mm thickness frame)				
	Q	O	R	P	
	13.5	0.5 ~ 2	15	2.5	

Table 3: Mechanical dimensions, specification and material when modules installed with mid clamps

### 2.3.2.1 Clamp Mounting on Long Sides of the Frames

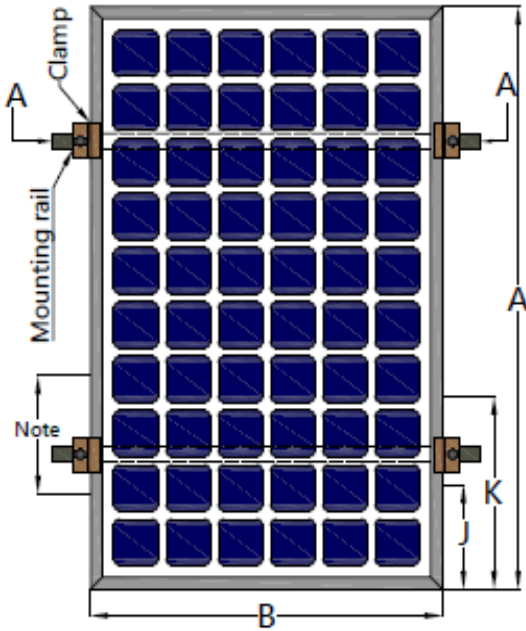

Figure 5: Installation of clamps on long side of frames

Module type	Dimension (mm)		
	Max. Test Pressure: 5400Pa (positive) & 2400Pa (negative)		
	A*B	J	K
Group 2	1665*992 & 1684*1002	400	420
Group 5	1987*992 & 2000*992 & 2008*1002	400	480
Group 8	1665*992 & 1684*1002	400	420
Group 11	1987*992 & 2000*992 & 2008*1002	400	480
Group 1/Group 3	1650*992 & 1665*1002	400	420
Group 4/Group 6	1956*992 & 1979*1002	400	480
Group 7/Group 9	1650*992 & 1665*1002	400	420
Group10/Group 12	1956*992 & 1979*1002	400	480
Group13/Group 15	2031*1008	280	420
Group14/Group 16	1704*1008	280	420

Table 4: Mechanical dimensions of modules installed with clamps on long side of frame

### 2.3.2.2 Clamp Mounting on Short Sides of the Frames

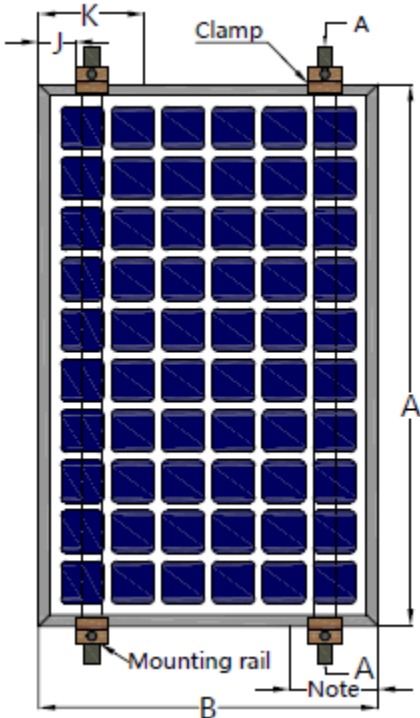
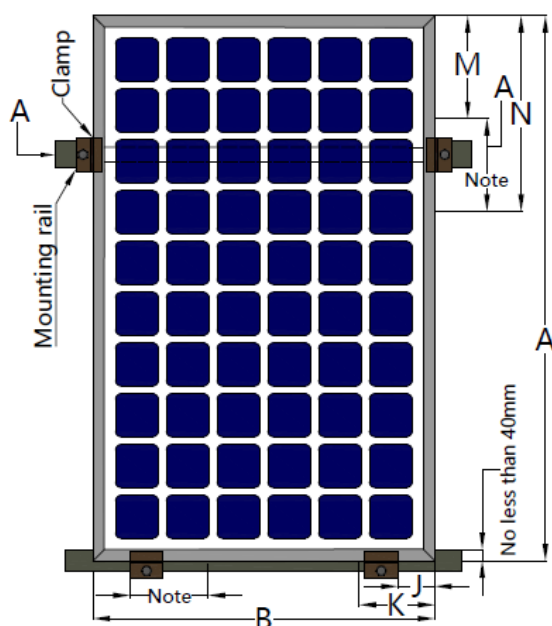

Figure 6: Installation of clamps on short side of frames

Module type	Dimension (mm)		
	Max. Test Pressure: 1600Pa (positive) & 1600Pa (negative)		
	A*B	J	K
Group 2	1665*992 & 1684*1002	50	240
Group 8	1665*992 & 1684*1002	50	240
Group 11	1987*992 & 2000*992 & 2008*1002	50	240
Group 5	1987*992 & 2000*992 & 2008*1002	50	240
Group 1 Group 3	1650*992 & 1665*1002	50	240
Group 7 Group 9	1650*992 & 1665*1002	50	240
Group 4 Group 6	1956*992 & 1979*1002	50	240
Group 10/Group 12	1956*992 & 1979*1002	50	240
Group13/Group 15	2031*1008	50	240
Group14/Group 16	1704*1008	50	240

Table 5: Mechanical dimensions of modules installed with clamps on short side of frame

### 2.3.2.3 Clamp Mounting on Long & Short Sides



**Figure 7: Installation of clamps on long & short side of frame**

Module type	Dimension (mm)				
	Max. Test Pressure: 2400Pa (positive) & 2400Pa (negative)				
	A*B	J	K	M	N
Group 1 Group 3	1650*992 & 1665*1002	50	240	400	420
Group 7 Group 9	1650*992 & 1665*1002	50	240	400	420
Group 4 Group 6	1956*992 & 1979*1002	50	240	400	480
Group 10 Group 12	1956*992 & 1979*1002	50	240	400	480
Group 2	1665*992 & 1684*1002	50	240	400	420
Group 5	1665*992 & 1684*1002	50	240	400	420
Group 8	1987*992 & 2000*992 & 2008*1002	50	240	400	480
Group 11	1987*992 & 2000*992 & 2008*1002	50	240	400	480
Group 13 Group 15	2031*1008	50	240	400	480
Group 14 Group 16	1704*1008	50	240	400	480

**Table 6: Mechanical dimensions of modules installed with clamps on long & short side of frame**

Note:

The installation method of clamps on short sides is based on the internal results in Jinko, not evaluated by UL.

The installation method of clamps on long and short sides is based on the internal results in Jinko, not evaluated by UL.

## 3. Wiring and Connection

- Before this procedure, please read the operation instructions of the PV system carefully. Connect the PV module connections in series or parallel, which is determined by the user's configuration requirement for system power, current and voltage.
- PV modules connected in series should have similar current, and modules must not be connected together to create a voltage higher than the permitted system voltage. The maximum number of modules in series depends on system design, the type of inverter and environmental conditions.

- c) The maximum fuse rating value in an array string can be found on the product label or in the product data sheet. The fuse rating value is also corresponding to the maximum reverse current that a module can withstand, i.e. when one string shaded then the other parallel strings of modules will be loaded by the shaded string and the current will pass through to create a current circuit. Based on the maximum series fuse rating of the module and local electrical codes and standards, make sure the modules strings in parallel are protected with the appropriate in-line string fusing.
- d) Connect the conductors from the PV array to the combiner box in accordance with the design and local codes and standards. The cross-sectional area and cable connector capacity must satisfy the maximum short-circuit of the PV system (for a single component, it is recommended the cross-sectional area of cables be 4mm<sup>2</sup> and the rated current of connectors be more than 10A, otherwise cables and connectors will become overheated from high current. Please note the temperature limit of the cables is 85°C.
- e) Jinko modules can be grounded using bolts. Attach the equipment grounding conductor to the module frame using the hole and hardware provided. Note that a stainless steel bolt is used between the ground wire and module frame as illustrated in following figure. A washer is used to avoid corrosion due to dissimilar metals. Tighten the screw securely. It is recommended that the applied torque is 1.7~2.0 ft-lbs (2.3 to 2.8 N\*m).

Module	Mounting hardware configuration			
	Hardware	Material	Size	Number provided
Group 1 ~ 16	Bolt	Stainless steel	M4	2
	Spring washer	Stainless steel	M4	2
	Nut	Stainless steel	M4	2
	Star washer	Stainless steel	M4	2
	Plain washer	Stainless steel	M4	4

**Table 7: The mounting part of the ground mounting hole**

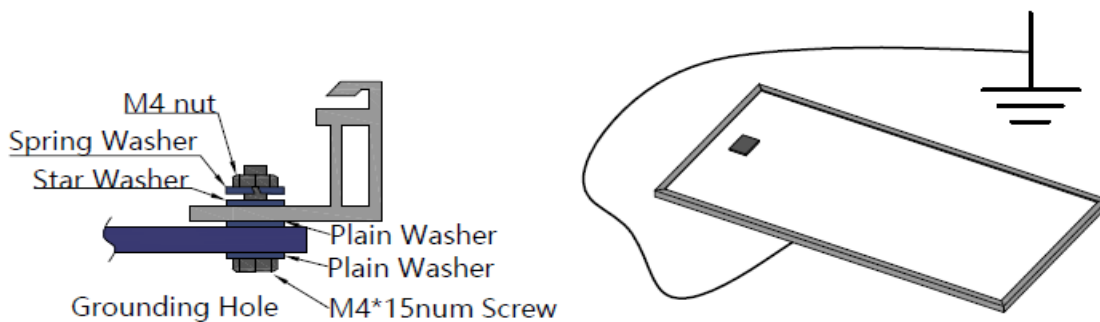

**Figure 8: Ground installation of PV modules**

The use of bolt grounding device is not allowed unless the grounding device is UL1703 or UL2703 certified with Jinko modules. Alternate grounding options built into the racking system are acceptable as long as they have been UL approved.

Model series	Grounding Clip	
	Manufacturer	Type
Group 1 ~ 16	Tyco Electronics Corp	1954381-1

**Table 8: The ground mounting Clip of PV modules**

- f) The following UL Listed Ground Clamp in combination with the following model number PV modules can be used. Other third party grounding method can't be used unless the grounding device is UL2703 certified with Jinko modules.
- g) Follow the requirements of applicable local and national electrical codes.
- h) These modules contain factory installed bypass diode. If these modules are incorrectly connected to each other, the bypass diodes, cable or junction box may be damaged.
- i) The module shall be wired in accordance with the NEC, the grounding method of the frame of arrays shall comply with the NEC, article 250
- j) CNL models shall be in accordance with CSA C22.1, Safety Standard for Electrical Installations, Canadian Electrical Code, Part 1.
- k) It is recommended that the M8 bolt be tightened to a torque of about 16 ~ 20 N\*m .
- l) The cable of the junction box is defined as L1, as showed below. For Jinko standard module, L1 is 900/1200mm; and for customized module, L1 can be based on your condition, take the cable length into consideration before designing the wiring layout.
- m) Jinko Solar requires the negative grounding of the inverter when a system is installed with standard (non-Eagle line) PV solar modules. Alternatively, a "charge-equalizing" device may be used to mitigate the effects of the Potential Induced Degradation (PID) phenomenon that can occur in specific environments that the array is installed in.

**Figure 10: Junction box**

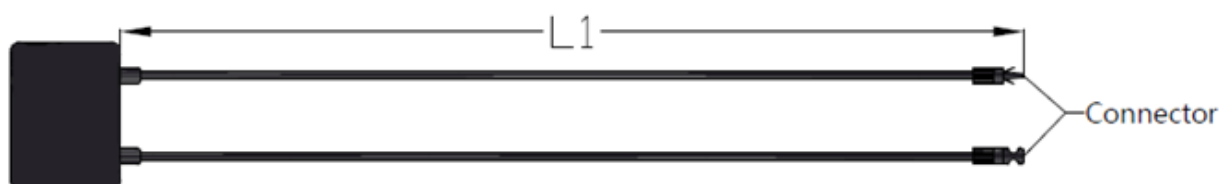

## 4. Maintenance and Care

- a) A build up of dust or dirt on the module(s) front glass will result in decreased energy output. Clean the module(s) preferably once annually if possible (depending on site conditions) using a soft dry or damp cloth, as necessary.
- b) Never use abrasive material under any circumstances.



- c) Examine the PV module(s) for signs of deterioration. Check all wiring for possible rodent damage, weathering and that all connections are tight and corrosion free. Check electrical leakage to ground.
- d) Check screws/bolts and mounting brackets are tight, adjust and tighten as necessary.
- e) Check the junction box and diodes as well. If you have any diodes problem, please contact Jinko Solar.
- f) When cleaning the modules, it is not allowed to stand on the module.
- g) Never use chemicals when cleaning modules as this may affect the module warranty and energy output.

## 5. Electrical Specification

The module electrical ratings are measured under Standard Test Conditions, which are 1000W/m<sup>2</sup>, irradiance with AM 1.5 spectrum and 25 deg C (77° F) ambient temperature. The module might produce more or less voltage or current than rated value in uncertainty condition. Tables below are electrical characteristics of PV products at STC and the tolerance of Isc, Voc, Vmp and Imp is ±10%.

## 6. Disclaimer of Liability

Because the use of the manual and the conditions or methods of installation, operation, use and maintenance of photovoltaic (PV) product are beyond Jinko's control, Jinko does not accept responsibility and expressly disclaims liability for loss, damage, or expense arising out of or in any way connected with such installation, operation, use or maintenance.

No responsibility is assumed by Jinko for any infringement of patents or other rights of third parties, which may result from use of the PV product. NO license is granted by implication or otherwise under any patent or patent rights.

The information in this manual is based on Jinko's knowledge and experience and is believed to be reliable, but such information including product specification (without limitations) and suggestions do not constitute a warranty, expresses or implied. Jinko reserves the right to change the installation manual, the PV product, the electrical specifications, or product information sheets without prior notice.

## Appendix 1: Applicable Products

This document is applicable to the series of solar modules as listed below:

### Group 1

JKMxxxP-60	JKMxxxP-60B <sup>①</sup>	JKMxxxP-60-J4 <sup>②</sup>	JKMxxxP-60B-J4
JKMxxxPP-60 <sup>③</sup>	JKMxxxPP-60B	JKMxxxPP-60(Plus) <sup>④</sup>	JKMxxxPP-60-J4
JKMxxxPP-60B-J4	JKMxxxPP-60-W <sup>⑤</sup>	JKMxxxPP-60B-W	JKMxxxPP-60B-V
JKMxxxP-60-V <sup>⑥</sup>	JKMxxxPP-60-V	JKMxxxPP-60-V(Plus)	JKMxxxPP-60-WV

(xxx=200~300, in increment of 5)

### Group 2

JKMxxxPP-60H <sup>⑦</sup>	JKMxxxPP-60H-J4	JKMxxxPP-60HB	
JKMxxxPP-60H-V	JKMxxxPP-60H-J4-V	JKMxxxPP-60HB-V	JKMxxxPP-60H-V

(xxx =200~310, in increment of 5)

### Group 3

JKMS <sup>®</sup> xxxP-60	JKMSxxxP-60-J4	JKMSxxxP-60B	JKMSxxxP-60B-J4
JKMSxxxPP-60	JKMSxxxPP-60-J4	JKMSxxxPP-60B-J4	JKMSxxxPP-60B
JKMSxxxPP-60-W	JKMSxxxPP-60B-W		

(xxx =200~275, in increment of 5)

### Group 4

JKMxxxP-72	JKMxxxP-72B	JKMxxxP-72-J4	JKMxxxP-72B-J4
JKMxxxPP-72	JKMxxxPP-72B	JKMxxxPP-72(Plus)	JKMxxxPP-72-J4
JKMxxxPP-72B-J4	JKMxxxPP-72-W	JKMxxxPP-72B-W	JKMxxxPP-72B-V
JKMxxxP-72-V	JKMxxxPP-72-V	JKMxxxPP-72-V(Plus)	JKMxxxPP-72-WV

(xxx =250~360, in increment of 5)

### Group 5

JKMxxxPP-72H	JKMxxxPP-72H-J4	JKMxxxPP-72HB	
JKMxxxPP-72H-V	JKMxxxPP-72H-J4-V	JKMxxxPP-72HB-V	

(xxx =250~370, in increment of 5)

### Group 6

JKMSxxxP-72	JKMSxxxP-72-J4	JKMSxxxP-72B-J4	JKMSxxxP-72B
JKMSxxxPP-72	JKMSxxxPP-72-J4	JKMSxxxPP-72B-J4	JKMSxxxPP-72B
JKMSxxxPP-72-W	JKMSxxxPP-72B-W		

(xxx =250~330, in increment of 5)

### Group 7

JKMxxxM-60	JKMxxxM-60B	JKMxxxM-60-J4	JKMxxxM-60B-J4
JKMxxxM-60-W	JKMxxxM-60B-W		
JKMxxxM-60-V	JKMxxxM-60-W-V	JKMxxxM-60B-V	

(xxx =200~330, in increment of 5)

JKMxxxM-60L <sup>⑨</sup>	JKMxxxM-60BL	JKMxxxM-60L-V	JKMxxxM-60BL-V
--------------------------	--------------	---------------	----------------

(xxx =300~330, in increment of 5)

Group 8

JKMxxxM-60H	JKMxxxM-60HB	JKMxxxM-60H-V	JKMxxxM-60HB-V
-------------	--------------	---------------	----------------

(xxx =200~340, in increment of 5)

JKMxxxM-60HL	JKMxxxM-60HBL	JKMxxxM-60HL-V	JKMxxxM-60HBL-V
--------------	---------------	----------------	-----------------

(xxx =300~340, in increment of 5)

Group 9

JKMSxxxM-60	JKMSxxxM-60-J4	JKMSxxxM-60-W	
-------------	----------------	---------------	--

(xxx =200~295, in increment of 5)

Group 10

JKMxxxM-72	JKMxxxM-72B	JKMxxxM-72-J4	JKMxxxM-72B-J4
------------	-------------	---------------	----------------

JKMxxxM-72-W	JKMxxxM-72B-W		
--------------	---------------	--	--

JKMxxxM-72-V	JKMxxxM-72-W-V	JKMxxxM-72B-V	
--------------	----------------	---------------	--

(xxx =250~400, in increment of 5)

JKMxxxM-72L	JKMxxxM-72L-V	JKMxxxM-72BL	JKMxxxM-72BL-V
-------------	---------------	--------------	----------------

(xxx =370~400, in increment of 5)

Group 11

JKMxxxM-72H	JKMxxxM-72HB	JKMxxxM-72H-V	JKMxxxM-72HB-V
-------------	--------------	---------------	----------------

(xxx =250~410, in increment of 5)

JKMxxxM-72HL	JKMxxxM-72HL-V	JKMxxxM-72HBL	JKMxxxM-72HBL-V
--------------	----------------	---------------	-----------------

(xxx =370~410, in increment of 5)

Group 12

JKMSxxxM-72	JKMSxxxM-72-J4	JKMSxxxM-72-W	
-------------	----------------	---------------	--

(xxx =250~355, in increment of 5)

Group 13

JKMxxxM-72HL-TV			
-----------------	--	--	--

(xxx =375~420, in increment of 5)

JKMBxxxM-72HL-TV			
------------------	--	--	--

(xxx =410~455, in increment of 5)

Group 14

JKMxxxM-60HL-TV			
-----------------	--	--	--

(xxx =315~350, in increment of 5)

JKMBxxxM-60HL-TV			
------------------	--	--	--

(xxx =345~380, in increment of 5)

Group 15

JKMxxxN-72HL-TV			
-----------------	--	--	--

(xxx =375~400, in increment of 5)

JKMBxxxN-72HL-TV			
------------------	--	--	--

(xxx =420~445, in increment of 5)

Group 16

JKMxxxN-60HL-TV			
-----------------	--	--	--

(xxx =315~330, in increment of 5)

JKMBxxxN-60HL-TV			
------------------	--	--	--

(xxx =350~365, in increment of 5)

Notes :

- ◆ B: module with black back sheet
- ◆ J4: the eagle black series module
- ◆ PP: the eagle series module
- ◆ Plus: the eagle+ series module
- ◆ W: module with metal support bar
- ◆ V: module with 1500V
- ◆ H: half-cut series module
- ◆ JKMS: the smart module
- ◆ L: large cell series module
- ◆ TV: SWAN bifacial module

## Appendix 2: Electrical Specifications

Module Type	Group 1 and Group 2											
xxx =	200	205	210	215	220	225	230	235	240	245	250	
Maximum Power at STC (Pmax, Wp)	200	205	210	215	220	225	230	235	240	245	250	
Maximum Power Voltage (Vmp, V)	28.2	28.4	28.6	28.8	29.0	29.2	29.4	29.6	29.8	30.1	30.5	
Maximum Power Current (Imp, A)	7.09	7.22	7.34	7.47	7.59	7.71	7.82	7.94	8.06	8.14	8.20	
Open-circuit Voltage (Voc, V)	35.3	35.5	35.8	36.1	36.3	36.6	36.8	37.0	37.3	37.5	37.7	
Short-circuit Current (Isc, A)	8.09	8.18	8.25	8.31	8.41	8.48	8.56	8.65	8.71	8.76	8.85	
Module Type	Group 1 and Group 2										Group 2	
xxx =	255	260	265	270	275	280	285	290	295	300	305	310
Maximum Power at STC (Pmax, Wp)	255	260	265	270	275	280	285	290	295	300	305	310
Maximum Power Voltage (Vmp, V)	30.8	31.1	31.4	31.7	32.0	32.3	32.5	32.8	33.1	33.4	33.6	33.9
Maximum Power Current (Imp, A)	8.28	8.37	8.44	8.52	8.61	8.69	8.77	8.86	8.95	9.03	9.11	9.19
Open-circuit Voltage (Voc, V)	38.0	38.1	38.6	38.8	39.1	39.4	39.6	39.8	40.1	40.3	40.6	40.8

Short-circuit Current (Isc, A)	8.92	8.98	9.03	9.09	9.15	9.20	9.26	9.32	9.37	9.43	9.49	9.59
Maximum system Voltage	1000VDC/1500VDC											
Dimensions	Normal PV module :1650x992x40mm (64.97x39.05 x1.57 inch) Large cell PV module :1665x1002x40mm (65.55x39.45 x1.57 inch) Half-cut PV module:1665x992x40mm (65.55x39.05 x1.57 inch) Large cell Half-cut PV module :1684x1002x40mm (66.30x39.45 x1.57 inch) Large cell PV module :1665x1002x35mm (65.55x39.45 x1.38 inch) Normal PV module :1650x992x35mm (64.97x39.05 x1.38 inch) Half-cut PV module:1665x992x35mm (65.55x39.05 x1.38 inch) Large cell Half-cut PV module :1684x1002x35mm (66.30x39.45 x1.38 inch)											
Maximum series overcurrent protective device rating	20A											

Module Type	Group 3							
xxx =	200	205	210	215	220	225	230	235
Maximum Power at STC (Pmax, Wp)	200	205	210	215	220	225	230	235
Maximum Power Voltage (Vmp, V)	26.8	27.0	27.2	27.4	27.6	27.2	27.9	28.1
Maximum Power Current (Imp, A)	7.46	7.60	7.73	7.86	7.98	8.12	8.23	8.36
Open-circuit Voltage(Voc, V)	33.5	33.7	34.0	34.3	34.5	34.8	35.0	35.2
Short-circuit Current (Isc, A)	8.53	8.61	8.68	8.75	8.85	8.92	9.01	9.10
Module Type	Group 3							
xxx=	240	245	250	255	260	265	270	275
Maximum Power at STC (Pmax, Wp)	240	245	250	255	260	265	270	275
Maximum Power Voltage (Vmp, V)	28.3	28.6	29.0	29.3	29.5	29.8	30.1	30.5
Maximum Power Current (Imp, A)	8.48	8.57	8.63	8.72	8.81	8.88	8.97	9.06
Open-circuit Voltage (Voc, V)	35.4	35.6	35.8	36.1	36.2	36.7	36.9	37.2

Short-circuit Current (Isc, A)	9.17	9.23	9.32	9.39	9.45	9.51	9.57	9.58
Maximum system Voltage	1000VDC							
Dimensions	Normal PV module :1650x992x40mm (64.97x39.05 x1.57 inch) Large cell PV module :1665x1002x40mm (65.55x39.45 x1.57 inch) Large cell PV module :1665x1002x35mm (65.55x39.45 x1.38 inch) Normal PV module :1650x992x35mm (64.97x39.05 x1.38 inch)							
Maximum series overcurrent protective device rating	15A							

Module Type	Group 4 and Group 5												
xxx =	250	255	260	265	270	275	280	285	290	295	300	305	
Maximum Power at STC (Pmax, Wp)	250	255	260	265	270	275	280	285	290	295	300	305	
Maximum Power Voltage (Vmp, V)	34.2	34.5	34.7	34.9	35.0	35.2	35.3	35.5	35.8	36.2	36.6	36.8	
Maximum Power Current (Imp, A)	7.31	7.39	7.49	7.59	7.71	7.81	7.93	8.03	8.11	8.15	8.20	8.30	
Open-circuit Voltage (Voc, V)	43.5	43.7	43.9	44.1	44.2	44.4	44.5	44.7	44.9	45.1	45.3	45.6	
Short-circuit Current (Isc, A)	8.05	8.18	8.26	8.33	8.43	8.49	8.58	8.61	8.69	8.76	8.84	8.91	
Module Type	Group 4 and Group 5											Group 5	
xxx =	310	315	320	325	330	335	340	345	350	355	360	365	370
Maximum Power at STC (Pmax, Wp)	310	315	320	325	330	335	340	345	350	355	360	365	370
Maximum Power Voltage (Vmp, V)	37.0	37.2	37.4	37.6	37.8	38	38.2	38.4	38.6	38.9	39.1	39.3	39.5
Maximum Power Current (Imp, A)	8.38	8.48	8.56	8.66	8.74	8.82	8.9	8.98	9.07	9.12	9.21	9.29	9.37
Open-circuit Voltage (Voc, V)	45.9	46.2	46.4	46.7	46.9	47.2	47.5	47.8	48	48.2	48.5	48.8	49.1
Short-circuit Current (Isc, A)	8.96	9.01	9.05	9.1	9.14	9.18	9.22	9.29	9.36	9.43	9.51	9.58	9.63
Maximum system Voltage	1000VDC/1500VDC												

Dimensions	<p>Normal PV module :1956x992x40mm (77.01x39.05 x1.57 inch)</p> <p>Large cell PV module :1979x1002x40mm (77.91x39.45 x1.57 inch)</p> <p>Half-cut PV module:1987x992x40mm (78.23x39.05 x1.57 inch)</p> <p>Large cell Half-cut PV module :2008x1002x40mm (79.06x39.45 x1.57 inch)</p> <p>Half-cut PV module:2000x992x40mm (78.74x39.05 x1.57 inch)</p>
Maximum series overcurrent protective device rating	20A

Module Type	Group 6								
xxx =	250	255	260	265	270	275	280	285	
Maximum Power at STC(Pmax, Wp)	250	255	260	265	270	275	280	285	
Maximum Power Voltage (Vmp, V)	32.5	32.8	33.0	33.2	33.3	33.4	33.5	33.7	
Maximum Power Current (Imp, A)	7.69	7.78	7.88	7.99	8.12	8.22	8.35	8.45	
Open-circuit Voltage (Voc, V)	41.3	41.5	41.7	41.9	42.0	42.2	42.3	42.5	
Short-circuit Current (Isc, A)	8.52	8.61	8.70	8.77	8.87	8.94	9.03	9.06	
Module Type	Group 6								
xxx=	290	295	300	305	310	315	320	325	330
Maximum Power at STC (Pmax, Wp)	290	295	300	305	310	315	320	325	330
Maximum Power Voltage(Vmp, V)	34.0	34.4	34.8	34.9	35.2	35.3	35.5	35.7	35.9
Maximum Power Current (Imp, A)	8.54	8.58	8.63	8.74	8.82	8.93	9.01	9.12	9.20
Open-circuit Voltage (Voc, V)	42.7	42.8	43.0	43.3	43.6	43.9	44.1	44.5	44.7
Short-circuit Current (Isc, A)	9.15	9.22	9.31	9.38	9.43	9.48	9.53	9.55	9.57
Maximum system Voltage	1000VDC								
Dimensions	Normal PV module :1956x992x40mm (77.01x39.05 x1.57 inch)								

	Large cell PV module :1979x1002x40mm (77.91x39.45 x1.57 inch)
Maximum series overcurrent protective device rating	15A

Module Type	Group 9									
xxx =	200	205	210	215	220	225	230	235	240	245
Maximum Power at STC (Pmax, Wp)	200	205	210	215	220	225	230	235	240	245
Maximum Power Voltage (Vmp, V)	28.2	28.4	28.6	28.8	29.0	29.2	29.4	29.6	29.8	30.1
Maximum Power Current (Imp, A)	7.09	7.22	7.34	7.47	7.59	7.71	7.82	7.94	8.06	8.14
Open-circuit Voltage (Voc, V)	35.3	35.5	35.8	36.1	36.3	36.6	36.8	37.0	37.3	37.5
Short-circuit Current (Isc, A)	8.09	8.18	8.25	8.31	8.41	8.48	8.56	8.65	8.71	8.76
Module Type	Group 9									
xxx=	250	255	260	265	270	275	280	285	290	295
Maximum Power at STC (Pmax, Wp)	250	255	260	265	270	275	280	285	290	295
Maximum Power Voltage(Vmp, V)	30.5	30.8	30.9	31.2	31.4	31.6	31.8	32.0	32.2	32.4
Maximum Power Current (Imp, A)	8.20	8.28	8.42	8.50	8.60	8.70	8.81	8.90	9.02	9.10
Open-circuit Voltage (Voc, V)	37.7	37.9	38.0	38.2	38.4	38.5	38.6	38.7	39.5	39.7
Short-circuit Current (Isc, A)	8.85	8.92	9.10	9.19	9.28	9.40	9.49	9.51	9.55	9.61
Maximum system Voltage	1000VDC									
Dimensions	Normal PV module :1650x992x40mm (64.97x39.05 x1.57 inch) Large cell PV module :1665x1002x40mm (65.55x39.45 x1.57 inch) Large cell PV module :1665x1002x35mm (65.55x39.45 x1.38 inch) Normal PV module :1650x992x35mm (64.97x39.05 x1.38 inch)									
Maximum series overcurrent protective	15A									



device rating	
---------------	--

Module Type	Group 7 and Group 8									
xxx =	200	205	210	215	220	225	230	235	240	245
Maximum Power at STC (Pmax, Wp)	200	205	210	215	220	225	230	235	240	245
Maximum Power Voltage (Vmp, V)	28.2	28.4	28.6	28.8	29.0	29.2	29.4	29.6	29.8	30.1
Maximum Power Current (Imp, A)	7.09	7.22	7.34	7.47	7.59	7.71	7.82	7.94	8.06	8.14
Open-circuit Voltage (Voc, V)	35.3	35.5	35.8	36.1	36.3	36.6	36.8	37.0	37.3	37.5
Short-circuit Current (Isc, A)	8.09	8.18	8.25	8.31	8.41	8.48	8.56	8.65	8.71	8.76
Module Type	Group 7 and Group 8									
xxx=	250	255	260	265	270	275	280	285	290	295
Maximum Power at STC (Pmax, Wp)	250	255	260	265	270	275	280	285	290	295
Maximum Power Voltage (Vmp, V)	30.5	30.8	30.9	31.2	31.4	31.6	31.8	32.0	32.2	32.4
Maximum Power Current (Imp, A)	8.20	8.28	8.42	8.50	8.60	8.70	8.81	8.90	9.02	9.10
Open-circuit Voltage (Voc, V)	37.7	38.0	37.9	38.2	38.4	38.5	38.6	38.7	39.5	39.7
Short-circuit Current (Isc, A)	8.85	8.96	9.10	9.19	9.28	9.40	9.49	9.51	9.55	9.61
Module Type	Group 7 and Group 8							Group 8		
xxx =	300	305	310	315	320	325	330	335	340	
Maximum Power at STC(Pmax, Wp)	300	305	310	315	320	325	330	335	340	
Maximum Power Voltage (Vmp, V)	32.6	32.8	33.0	33.2	33.4	33.6	33.8	34.0	34.2	
Maximum Power Current (Imp, A)	9.21	9.30	9.4	9.49	9.59	9.68	9.77	9.87	9.96	
Open-circuit Voltage (Voc, V)	40.1	40.3	40.5	40.7	40.9	41.1	41.3	41.5	41.7	
Short-circuit Current (Isc, A)	9.72	9.83	9.92	10.04	10.15	10.2	10.31	10.36	10.55	

Maximum system Voltage	1000VDC/1500VDC
Dimensions	<p>Normal PV module :1650x992x40mm (64.97x39.05 x1.57 inch)</p> <p>Half-cut PV module:1665x992x40mm (65.55x39.05 x1.57 inch)</p> <p>Large cell PV module :1665x1002x35mm (65.55x39.45 x1.38 inch)</p> <p>Normal PV module :1650x992x35mm (64.97x39.05 x1.38 inch)</p> <p>Half-cut PV module:1665x992x35mm (65.55x39.05 x1.38 inch)</p> <p>Large cell Half-cut PV module :1684x1002x35mm (66.30x39.45 x1.38 inch)</p>
Maximum series overcurrent protective device rating	20A

Module Type	Group 10 and Group 11												
xxx =	250	255	260	265	270	275	280	285	290	295	300	305	310
Maximum Power at STC (Pmax, Wp)	250	255	260	265	270	275	280	285	290	295	300	305	310
Maximum Power Voltage (Vmp, V)	34.8	35.0	35.3	35.6	35.9	36.1	36.3	36.5	36.7	36.8	37.0	37.2	37.4
Maximum Power Current (Imp, A)	7.18	7.29	7.37	7.44	7.52	7.62	7.71	7.81	7.90	8.02	8.11	8.20	8.29
Open-circuit Voltage (Voc, V)	43.4	43.6	43.9	44.1	44.4	44.6	44.8	45.0	45.2	45.3	45.5	45.7	45.9
Short-circuit Current (Isc, A)	7.84	7.92	7.99	8.07	8.15	8.23	8.32	8.40	8.47	8.55	8.64	8.72	8.80
Module Type	Group 10 and Group 11												
xxx =	315	320	325	330	335	340	345	350	355	360	365	370	
Maximum Power at STC (Pmax, Wp)	315	320	325	330	335	340	345	350	355	360	365	370	
Maximum Power Voltage (Vmp, V)	37.6	37.8	38.0	38.2	38.4	38.7	38.9	39.1	39.3	39.5	39.7	39.9	
Maximum Power Current (Imp, A)	8.38	8.47	8.55	8.64	8.72	8.79	8.87	8.94	9.04	9.12	9.20	9.28	
Open-circuit Voltage (Voc, V)	46.1	46.3	46.5	46.7	46.9	47.1	47.3	47.5	47.8	48.0	48.2	48.5	
Short-circuit Current (Isc, A)	8.87	8.95	9.03	9.11	9.18	9.24	9.31	9.38	9.45	9.51	9.57	9.61	

Module Type	Group 10 and Group 11						Group 11	
xxx =	375	380	385	390	395	400	405	410
Maximum Power at STC (Pmax, Wp)	375	380	385	390	395	400	405	410
Maximum Power Voltage (Vmp, V)	40.2	40.5	40.8	41.1	41.4	41.7	42.0	42.3
Maximum Power Current (Imp, A)	9.33	9.39	9.44	9.49	9.55	9.6	9.65	9.69
Open-circuit Voltage (Voc, V)	48.7	48.9	49.1	49.3	49.5	49.8	50.1	50.4
Short-circuit Current (Isc, A)	9.68	9.75	9.92	10.12	10.23	10.36	10.48	10.60
Maximum system Voltage	1000VDC/1500VDC							
Dimensions	Normal PV module :1956x992x40mm (77.01x39.05 x1.57 inch) Large cell PV module :1979x1002x40mm (77.91x39.45 x1.57 inch) Half-cut PV module:1987x992x40mm (78.23x39.05 x1.57 inch) Large cell Half-cut PV module :2008x1002x40mm (79.06x39.45 x1.57 inch) Half-cut PV module:2000x992x40mm (78.74x39.05 x1.57 inch)							
Maximum series overcurrent protective device rating	20A							

Module Type	Group 12											
xxx =	250	255	260	265	270	275	280	285	290	295	300	305
Maximum Power at STC (Pmax, Wp)	250	255	260	265	270	275	280	285	290	295	300	305
Maximum Power Voltage (Vmp, V)	34.8	35.0	35.3	35.6	35.9	36.1	36.3	36.5	36.7	36.8	37.0	37.2
Maximum Power Current (Imp, A)	7.18	7.29	7.37	7.44	7.52	7.62	7.71	7.81	7.90	8.02	8.11	8.20
Open-circuit Voltage (Voc, V)	43.4	43.6	43.9	44.1	44.4	44.6	44.8	45.0	45.2	45.3	45.5	45.7
Short-circuit Current (Isc, A)	7.84	7.92	7.99	8.07	8.15	8.23	8.32	8.40	8.47	8.55	8.64	8.72

Module Type	Group 12									
xxx=	310	315	320	325	330	335	340	345	350	355
Maximum Power at STC (Pmax, Wp)	310	315	320	325	330	335	340	345	350	355
Maximum Power Voltage(Vmp, V)	37.4	37.6	37.8	38.0	38.2	38.4	38.7	38.9	39.1	39.3
Maximum Power Current (Imp, A)	8.29	8.38	8.47	8.55	8.64	8.72	8.79	8.87	8.94	9.04
Open-circuit Voltage(Voc, V)	45.9	46.1	46.3	46.5	46.7	46.9	47.1	47.3	47.5	47.8
Short-circuit Current (Isc, A)	8.80	8.87	8.95	9.03	9.11	9.18	9.24	9.31	9.38	9.45
Maximum system Voltage	1000VDC									
Dimensions	Normal PV module :1956x992x40mm (77.01x39.05 x1.57 inch) Large cell PV module :1979x1002x40mm (77.91x39.45 x1.57 inch)									
Maximum series overcurrent protective device rating	15A									

Module Type	Group 13									
xxx =	375	380	385	390	395	400	405	410	415	420
Maximum Power at STC (Pmax, Wp)	375	380	385	390	395	400	405	410	415	420
Maximum Power Voltage (Vmp, V)	39.25	39.36	39.50	39.62	39.83	40.01	40.19	40.38	40.50	40.65
Maximum Power Current (Imp, A)	9.56	9.66	9.76	9.84	9.92	10.00	10.08	10.16	10.25	10.33
Open-circuit Voltage (Voc, V)	47.92	47.96	48.10	48.14	48.26	48.35	48.45	48.56	48.64	48.74
Short-circuit Current (Isc, A)	9.92	10.02	10.08	10.17	10.23	10.32	10.42	10.51	10.61	10.70
Module Type	Group 13									
xxx =	375	380	385	390	395	400	405	410	415	420
Maximum Power at BSTC (Pmax, Wp)	410	415	420	425	430	435	440	445	450	455

Maximum Power Voltage(Vmp, V)	39.25	39.36	39.50	39.62	39.83	40.01	40.19	40.38	40.50	40.65
Maximum Power Current (Imp, A)	10.46	10.57	10.68	10.77	10.86	10.94	11.03	11.11	11.22	11.31
Open-circuit Voltage(Voc, V)	47.92	47.96	48.10	48.14	48.26	48.35	48.45	48.56	48.64	48.74
Short-circuit Current (Isc, A)	10.86	10.97	11.03	11.13	11.20	11.30	11.40	11.51	11.61	11.71
Maximum system Voltage	1500VDC									
Dimensions	2031*1008*40 (79.96*39.69*1.57 inch)									
Maximum series overcurrent protective device rating	25A									
Bifaciality Coefficient	$\phi_{Isc}=[Isc(back)]/[Isc(front)]= 0.71$ $\phi_{Voc}=[Voc(back)]/[Voc(front)]= 0.98$ $\phi_{Pmmp}=[Pmmp(back)]/[Pmmp(front)]= 0.70$									

Module Type	Group 14							
xxx =	315	320	325	330	335	340	345	350
Maximum Power at STC (Pmax, Wp)	315	320	325	330	335	340	345	350
Maximum Power Voltage (Vmp, V)	32.7	32.9	33.1	33.24	33.40	33.62	33.76	33.94
Maximum Power Current (Imp, A)	9.63	9.73	9.82	9.93	10.03	10.11	10.22	10.31
Open-circuit Voltage (Voc, V)	39.9	40.1	40.3	40.39	40.46	40.60	40.75	40.87
Short-circuit Current (Isc, A)	9.99	10.07	10.15	10.25	10.34	10.43	10.53	10.62
Module Type	Group 14							
xxx =	315	320	325	330	335	340	345	350
Maximum Power at BSTC (Pmax, Wp)	345	350	355	360	365	370	375	380
Maximum Power Voltage(Vmp, V)	32.7	32.9	33.10	33.24	33.40	33.62	33.76	33.94
Maximum Power Current (Imp, A)	10.54	10.65	10.75	10.87	10.98	11.07	11.18	11.29
Open-circuit Voltage(Voc, V)	39.9	40.1	40.30	40.39	40.46	40.60	40.75	40.87
Short-circuit Current (Isc, A)	10.93	11.02	11.11	11.22	11.32	11.42	11.52	11.62
Maximum system Voltage	1500VDC							

Dimensions	1704*1008*35 (67.09*39.69*1.38 inch)
Maximum series overcurrent protective device rating	25A
Bifaciality Coefficient	$\phi_{Isc}=[Isc(back)]/[Isc(front)]= 0.71$ $\phi_{Voc}=[Voc(back)]/[Voc(front)]= 0.98$ $\phi_{Pmmp}=[Pmmp(back)]/[Pmmp(front)]= 0.70$

Module Type	Group 15					
xxx =	375	380	385	390	395	400
Maximum Power at STC (Pmax, Wp)	375	380	385	390	395	400
Maximum Power Voltage (Vmp, V)	39.32	39.43	39.53	39.64	39.74	39.85
Maximum Power Current (Imp, A)	9.54	9.64	9.74	9.84	9.94	10.04
Open-circuit Voltage (Voc, V)	48.10	48.20	48.31	48.40	48.50	48.63
Short-circuit Current (Isc, A)	10.07	10.17	10.26	10.36	10.45	10.54
Module Type	Group 15					
xxx =	375	380	385	390	395	400
Maximum Power at BSTC (Pmax, Wp)	420	425	430	435	440	445
Maximum Power Voltage (Vmp, V)	39.32	39.43	39.53	39.64	39.74	39.85
Maximum Power Current (Imp, A)	10.67	10.79	10.90	11.01	11.12	11.23
Open-circuit Voltage (Voc, V)	48.10	48.20	48.31	48.40	48.50	48.63
Short-circuit Current (Isc, A)	11.27	11.38	11.48	11.59	11.69	11.79
Maximum system Voltage	1500VDC					
Dimensions	2031*1008*40 (79.96*39.69*1.57 inch)					
Maximum series overcurrent protective device rating	25A					
Bifaciality Coefficient	$\phi_{Isc}=[Isc(back)]/[Isc(front)]= 0.89$ $\phi_{Voc}=[Voc(back)]/[Voc(front)]= 0.99$ $\phi_{Pmmp}=[Pmmp(back)]/[Pmmp(front)]= 0.88$					

Module Type	Group 16			
xxx =	315	320	325	330
Maximum Power at STC (Pmax, Wp)	315	320	325	330

Maximum Power Voltage (Vmp, V)	33.00	33.17	33.38	33.51
Maximum Power Current (Imp, A)	9.55	9.65	9.74	9.85
Open-circuit Voltage (Voc, V)	40.19	40.32	40.43	40.56
Short-circuit Current (Isc, A)	10.12	10.23	10.32	10.43
<b>Module Type</b>	<b>Group 16</b>			
xxx =	315	320	325	330
Maximum Power at BSTC (Pmax, Wp)	350	355	360	365
Maximum Power Voltage(Vmp, V)	33.00	33.17	33.38	33.51
Maximum Power Current (Imp, A)	10.68	10.80	10.90	11.02
Open-circuit Voltage(Voc, V)	40.19	40.32	40.43	40.56
Short-circuit Current (Isc, A)	11.32	11.45	11.55	11.67
Maximum system Voltage	1500VDC			
Dimensions	1704*1008*35 (67.09*39.69*1.38 inch)			
Maximum series overcurrent protective device rating	25A			
Bifaciality Coefficient	$\phi$ Isc=[Isc(back)]/[Isc(front)]= 0.89 $\phi$ Voc=[Voc(back)]/[Voc(front)]= 0.99 $\phi$ Pmmp=[Pmmp(back)]/[Pmmp(front)]= 0.88			

**Note**

---

---

---

---

---

---

---



## 7. Contact us

Jinko Solar Co., Ltd. (Shanghai Office)  
Jinko Building, #99 Shouyang Road, Jingan District, Shanghai, China  
Postcode: 200127  
Tel : (86)-21-51838777  
Fax : (86)-21-51808600

Jinko Solar Co., Ltd. (Jiangxi Manufacture base)  
No.1 Jinko Road, Shangrao Economic Development Zone, Jiangxi Province,  
China  
Postcode: 334100  
Tel: (86)-793-8588188  
Fax: (86)-793-8461152

Jinko solar Import and Export co., LTD  
Xuri District, Shangrao Economic Development Zone, Jiangxi Province, China  
Postcode: 334100  
Tel: +86-793-8618987  
Fax: +86-793-8461152  
Customer Service : [cs@jinkosolar.com](mailto:cs@jinkosolar.com)

JinkoSolar(U.S) Inc.  
595 Market Street, Suite 2200,  
San Francisco, CA 94105  
Tel: +(415) 402 0502  
Fax: +(415) 402 0703  
[us@jinkosolar.com](mailto:us@jinkosolar.com)

Jinko Solar Canada Co., Ltd.  
Suite 703, 100 Allsate Parkway, Markham, ON Canada L3R 6H3  
Tel: +1 905 604 2527  
Fax: +1 905 604 2687  
[canada@jinkosolar.com](mailto:canada@jinkosolar.com)

#### **Global Sales & Marketing Center**

Jinko Building  
#99 Shouyang Road, Jingan District,  
Shanghai, China 200027  
Tel: +86 21 5183 8777  
Fax: +86 21 5180 8600

#### **Jiangxi Manufacture Base**

No.1 Jinko Road,  
Shangrao Economic Development Zone,  
Jiangxi Province, China 334100  
Tel:+86 793 858 8188  
Fax:+86 793 846 1152

#### **Zhejiang Manufacture Base**

No.58 Yuanxi Road,  
Haining Yuanhua Industrial Park,  
Zhejiang Province, China 314416  
Tel: +86 573 8798 5678  
Fax: +86 573 8787 1070